

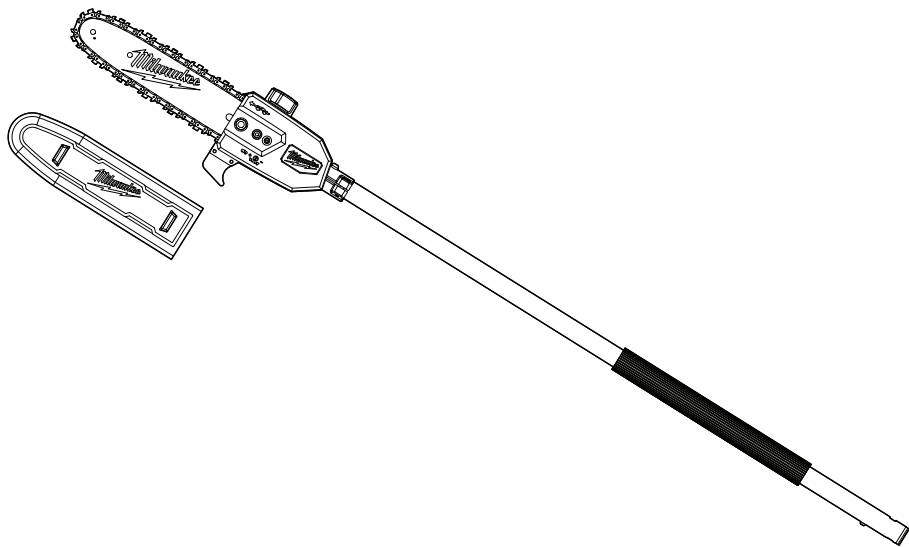

OPERATOR'S MANUAL



Cat. No.

M18 FOPH-CSA

M18 FUEL™ 10" POLE SAW ATTACHMENT W/ QUIK-LOK™

 **WARNING**

To reduce the risk of injury, user must read and understand operator's manual.



GENERAL POWER TOOL SAFETY WARNINGS

WARNING Read all safety warnings, instructions, illustrations and specifications provided with this power tool. Failure to follow all instructions listed below may result in electric shock, fire and/or serious injury. **Save all warnings and instructions for future reference.** The term "power tool" in the warnings refers to your mains-operated (corded) power tool or battery-operated (cordless) power tool.

WORK AREA SAFETY

- **Keep work area clean and well lit.** Cluttered or dark areas invite accidents.
- **Do not operate power tools in explosive atmospheres, such as in the presence of flammable liquids, gases or dust.** Power tools create sparks which may ignite the dust or fumes.
- **Keep children and bystanders away while operating a power tool.** Distractions can cause you to lose control.

ELECTRICAL SAFETY

- **Power tool plugs must match the outlet. Never modify the plug in any way. Do not use any adapter plugs with earthed (grounded) power tools.** Unmodified plugs and matching outlets will reduce risk of electric shock.
- **Avoid body contact with earthed or grounded surfaces, such as pipes, radiators, ranges and refrigerators.** There is an increased risk of electric shock if your body is earthed or grounded.
- **Do not expose power tools to rain or wet conditions.** Water entering a power tool will increase the risk of electric shock.
- **Do not abuse the cord. Never use the cord for carrying, pulling or unplugging the power tool. Keep cord away from heat, oil, sharp edges or moving parts.** Damaged or entangled cords increase the risk of electric shock.
- **When operating a power tool outdoors, use an extension cord suitable for outdoor use.** Use of a cord suitable for outdoor use reduces the risk of electric shock.
- **If operating a power tool in a damp location is unavoidable, use a residual current device (RCD) protected supply.** Use of a RCD reduces the risk of electric shock.

PERSONAL SAFETY

- **Stay alert, watch what you are doing and use common sense when operating a power tool. Do not use a power tool while you are tired or under the influence of drugs, alcohol or medication.** A moment of inattention while operating power tools may result in serious personal injury.
- **Use personal protective equipment. Always wear eye protection.** Protective equipment such as a dust mask, non-skid safety shoes, hard hat or hearing protection used for appropriate conditions will reduce personal injuries.
- **Prevent unintentional starting. Ensure the switch is in the off-position before connecting to power source and/or battery pack, picking up or carrying the tool.** Carrying power tools with your finger on the switch or energising power tools that have the switch on invites accidents.

- **Remove any adjusting key or wrench before turning the power tool on.** A wrench or a key left attached to a rotating part of the power tool may result in personal injury.
- **Do not overreach. Keep proper footing and balance at all times.** This enables better control of the power tool in unexpected situations.
- **Dress properly. Do not wear loose clothing or jewelry. Keep your hair and clothing away from moving parts.** Loose clothes, jewelry or long hair can be caught in moving parts.
- **If devices are provided for the connection of dust extraction and collection facilities, ensure these are connected and properly used.** Use of dust collection can reduce dust-related hazards.
- **Do not let familiarity gained from frequent use of tools allow you to become complacent and ignore tool safety principles.** A careless action can cause severe injury within a fraction of a second.

POWER TOOL USE AND CARE

- **Do not force the power tool. Use the correct power tool for your application.** The correct power tool will do the job better and safer at the rate for which it was designed.
- **Do not use the power tool if the switch does not turn it on and off.** Any power tool that cannot be controlled with the switch is dangerous and must be repaired.
- **Disconnect the plug from the power source and/ or remove the battery pack, if detachable, from the power tool before making any adjustments, changing accessories, or storing power tools.** Such preventive safety measures reduce the risk of starting the power tool accidentally.
- **Store idle power tools out of the reach of children and do not allow persons unfamiliar with the power tool or these instructions to operate the power tool.** Power tools are dangerous in the hands of untrained users.
- **Maintain power tools and accessories. Check for misalignment or binding of moving parts, breakage of parts and any other condition that may affect the power tool's operation. If damaged, have the power tool repaired before use.** Many accidents are caused by poorly maintained power tools.
- **Keep cutting tools sharp and clean.** Properly maintained cutting tools with sharp cutting edges are less likely to bind and are easier to control.
- **Use the power tool, accessories and tool bits etc. in accordance with these instructions, taking into account the working conditions and the work to be performed.** Use of the power tool for operations different from those intended could result in a hazardous situation.
- **Keep handles and grasping surfaces dry, clean and free from oil and grease.** Slippery handles and grasping surfaces do not allow for safe handling and control of the tool in unexpected situations.

BATTERY TOOL USE AND CARE

- **Recharge only with the charger specified by the manufacturer.** A charger that is suitable for one type of battery pack may create a risk of fire when used with another battery pack.
- **Use power tools only with specifically designated battery packs.** Use of any other battery packs may create a risk of injury and fire.

- When battery pack is not in use, keep it away from other metal objects, like paper clips, coins, keys, nails, screws or other small metal objects, that can make a connection from one terminal to another. Shorting the battery terminals together may cause burns or a fire.
- Under abusive conditions, liquid may be ejected from the battery; avoid contact. If contact accidentally occurs, flush with water. If liquid contacts eyes, additionally seek medical help. Liquid ejected from the battery may cause irritation or burns.
- Do not use a battery pack or tool that is damaged or modified. Damaged or modified batteries may exhibit unpredictable behavior resulting in fire, explosion or risk of injury.
- Do not expose a battery pack or tool to fire or excessive temperature. Exposure to fire or temperature above 130°C (265°F) may cause explosion.
- Follow all charging instructions and do not charge the battery pack or tool outside the temperature range specified in the instructions. Charging improperly or at temperatures outside the specified range may damage the battery and increase the risk of fire.

SERVICE

- Have your power tool serviced by a qualified repair person using only identical replacement parts. This will ensure that the safety of the power tool is maintained.
- Never service damaged battery packs. Service of battery packs should only be performed by the manufacturer or authorised service providers.

SPECIFIC SAFETY RULES FOR POLE SAW

- Before use, read this manual, and all manuals and labels of this tool and its power head. Failure to follow the warnings and instructions may result in serious injury. Use tool only as described in this manual. Use only attachments recommended by MILWAUKEE®.
- Always wear eye, hearing, and head protection, and protective clothing and footwear, according to the operation being performed. Wear heavy, long pants, long sleeves, boots, and gloves. Contain long hair. Do not wear loose clothing or jewelry. Do not wear short pants, sandals, or go barefoot.
- Keep bystanders at least 15m (50') away during use.
- This tool is for use in trimming and pruning wood only. Do not use for felling trees or branches over 228 mm (9") diameter, or cutting other materials such as metal or plastic. Do not cut vines and/or small underbrush.
- WARNING** Do not operate near electric power lines. The unit has not been designed to provide protection from electric shock in the event of contact with electric power lines. Consult local regulations for safe distances from electric power lines and ensure that the operating position is safe and secure before use.
- Do not extend tool by more than one attachment extension. Additional attachment extensions will make the pole unstable and difficult to control, which could result in injury.
- When using this attachment with larger-capacity battery packs, use the shoulder strap to reduce user fatigue and help in maintaining control of

the tool during use.

- Do not operate the tool without the front handle in place. The front handle must be attached properly during use. Use both hands when operating the tool, according to the attachment instructions. Maintain a firm grip. Using one hand could cause loss of control and result in serious injury.
- Do not operate a pole saw in a tree, on a ladder, from a rooftop, or any unstable support. Operation of a pole saw in this manner could result in serious personal injury.
- Identify a clear retreat path before beginning a cut. Falling limbs and branches will cause injury.
- Keep face, hands and feet clear of moving parts at all times. Moving parts can cause severe lacerations.
- Before you start the tool, make sure the saw chain is not contacting anything. A moment of inattention while operating saws may cause entanglement of your clothing or body with the saw chain.
- Hold the tool by insulated gripping surfaces only, because the saw chain may contact hidden wiring. Saw chains contacting a "live" wire may make exposed metal parts of the saw "live" and could give the operator an electric shock.
- Before starting the tool check the work area for hidden objects, such as wire fencing, posts, etc. Striking a solid object could cause loss of control and serious personal injury.
- Brace for unexpected movement when contact is made with a hard object. Loss of control could result in serious injury.
- Do not stand directly under branch/limb being cut. Falling debris will cause injury. Do not use tool at an angle greater than 60° to ground level.
- Always keep proper footing and operate the pole saw only when standing on fixed, secure and level surface. Slippery or unstable surfaces may cause a loss of balance or control of the tool.
- Do not overreach. This helps prevent unintended tip contact and enables better control of the tool in unexpected situations.

Causes and operator prevention of kickback:

Kickback may occur when the nose or tip of the guide bar touches an object, or when the wood closes in and pinches the saw chain in the cut.

Tip contact in some cases may cause a sudden reverse reaction, kicking the guide bar up and back towards the operator.

Pinching the saw chain along the top of the guide bar may push the guide bar rapidly back towards the operator.

Either of these reactions may cause you to lose control of the tool which could result in serious personal injury. Do not rely exclusively upon the safety devices built into your tool. As a pole saw user, you should take several steps to keep your cutting jobs free from accident or injury.

Kickback is the result of tool misuse and/or incorrect operating procedures or conditions and can be avoided by taking proper precautions as given below:

- Maintain a firm grip, with thumbs and fingers encircling the tool handles, with both hands on the tool and position your body and arm to allow you to resist kickback forces. Kickback forces can be controlled by the operator, if proper precautions are taken. Do not let go of the tool.
- Only use replacement guide bars and saw chains specified by the manufacturer. Incorrect replacement guide bars and saw chains may cause chain breakage and/or kickback.

• **Follow the manufacturer's sharpening and maintenance instructions for the saw chain.** Decreasing the depth gauge height can lead to increased kickback.

• **Follow all instructions when clearing jammed material, storing or servicing the tool. Make sure the switch is off and the battery pack is removed.** Unexpected actuation of the tool while clearing jammed material or servicing may result in serious personal injury.

• **Do not attempt to limb or trim a tree until you have an understanding of the risks and how to avoid them.** Serious injury could occur to the operator or bystanders while limbing or trimming a tree.

• **When cutting a limb that is under tension be alert for spring back.** When the tension in the wood fibres is released the spring loaded limb may strike the operator and/or throw the tool out of control.

• **Use extreme caution when cutting brush and saplings.** The slender material may catch the saw chain and be whipped toward you or pull you off balance.

• **Stop the tool before setting it down.**

• **Carry the tool by the front handle to avoid accidental starting.** Proper handling of the tool will prevent injury.

• **Always turn off the tool when transporting from one location to another.** Do not carry tool with finger on the trigger. Accidental starting can cause serious personal injury.

• **When transporting or storing the pole saw always fit the guide bar cover.** Proper handling of the pole saw will reduce the likelihood of accidental contact with the moving saw chain.

• **Do not immerse in water or spray with a hose. Do not clean with a pressure washer.** Water entering a power tool will increase the risk of electric shock. Store tool indoors.

• **Do not store the power tool on or near to fertilizers or chemicals.**

• **Always turn off the tool and then remove battery pack before changing or removing accessories.**

• **Use only recommended accessories. Others may be hazardous.**

• **Maintain the unit with care.** Keep the cutting edge sharp and clean for best performance and to reduce the risk of injury. Follow instructions for lubricating and changing accessories.

• **Chain is sharp. Always wear protective gloves when handling the chain.**

• **Follow instructions for lubricating, chain tensioning and changing the bar and chain.** Improperly tensioned or lubricated chain may either break or increase the chance for kickback.

Other Safety Rules

• **Keep ALL children, bystanders, visitors, and animals out of the work area while starting or cutting with the tool.**

• **Dress Properly - Wear snug fitting clothing.** Always wear heavy, long pants, long sleeves, overalls, jeans or chaps made of cut resistant material or ones that contain cut resistant inserts. Wear non-slip safety footwear. Wear non-slip heavy duty gloves to improve your grip and to protect your hands. Do not wear jewelry, short pants, sandals, or go barefoot. Do not wear loose fitting clothing, which could be drawn into the motor or catch the chain or underbrush. Secure hair so it is above shoulder level. Wear hearing and head protection.

• **Heavy protective clothing may increase operator fatigue, which could lead to heat stroke.** During

weather that is hot and humid, heavy work should be scheduled for early morning or late afternoon hours when temperatures are cooler.

• **Always be aware of what you are doing when using the tool. Use common sense.** Do not operate the tool when you are tired, ill, or under the influence of alcohol, drugs, or medication.

• **Keep all parts of your body away from the saw chain when the unit is running.**

• **Never let anyone use your tool who has not received adequate instructions in its proper use.** This applies to rentals as well as privately owned tools.

• **Do not hang from pull hook.**

• **Always use common sense and be cautious when using tools.** It is not possible to anticipate every situation that could result in a dangerous outcome. Do not use this tool if you do not understand these operating instructions or you feel the work is beyond your capability; contact Milwaukee Tool or a trained professional for additional information or training.

• **Follow the manufacturer's sharpening and maintenance instructions for the saw chain.** Decreasing the depth gauge height can lead to increased kickback.

• **Keep handles dry, clean, and free from oil and grease.** Greasy, oily handles are slippery causing loss of control.

• **Maintain labels and nameplates.** These carry important information. If unreadable or missing, contact a MILWAUKEE® service facility for a replacement.

• **⚠WARNING** Some dust created by power sanding, sawing, grinding, drilling, and other construction activities contains chemicals known to cause cancer, birth defects or other reproductive harm. Some examples of these chemicals are:

• lead from lead-based paint

• crystalline silica from bricks and cement and other masonry products, and

• arsenic and chromium from chemically-treated lumber. Your risk from these exposures varies, depending on how often you do this type of work. To reduce your exposure to these chemicals: work in a well ventilated area, and work with approved safety equipment, such as those dust masks that are specially designed to filter out microscopic particles.

READ AND SAVE ALL INSTRUCTIONS FOR FUTURE USE

ADDITIONAL BATTERY SAFETY RULES

• **⚠WARNING** To reduce the risk of fire, personal injury, and product damage due to a short circuit, never immerse your tool, battery pack or charger in fluid or allow a fluid to flow inside them. Corrosive or conductive fluids, such as seawater, certain industrial chemicals, and bleach or bleach-containing products, etc., can cause a short circuit.

FUNCTIONAL DESCRIPTION

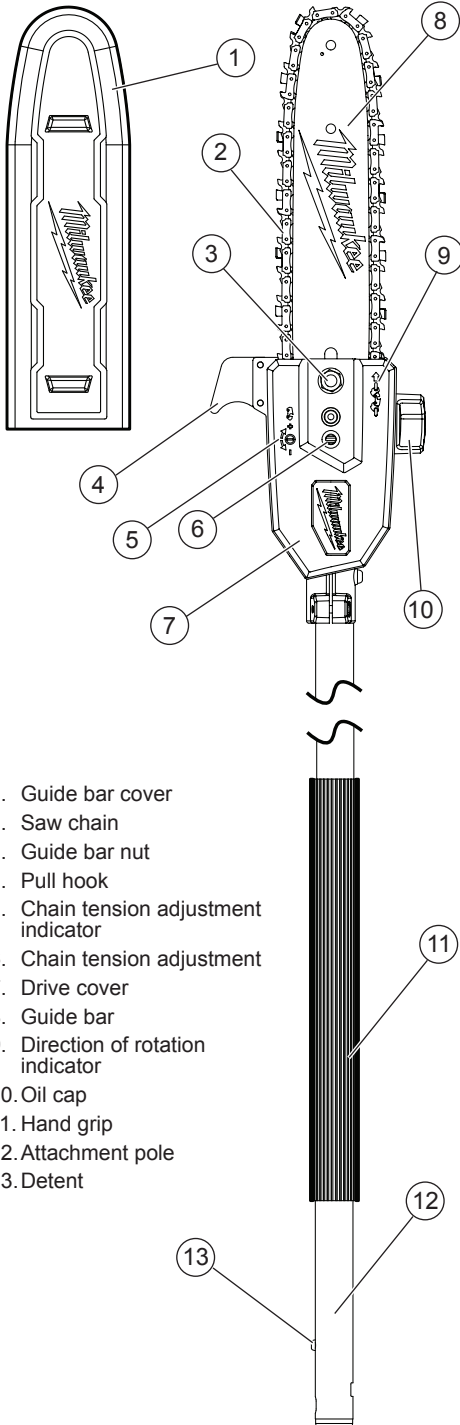

1. Guide bar cover
2. Saw chain
3. Guide bar nut
4. Pull hook
5. Chain tension adjustment indicator
6. Chain tension adjustment
7. Drive cover
8. Guide bar
9. Direction of rotation indicator
10. Oil cap
11. Hand grip
12. Attachment pole
13. Detent

SYMBOLGY

-  Volts
-  Direct Current
- n_0 XXXX min⁻¹ No Load Revolutions per Minute (RPM)
-  Safety Alert Symbol
-  Read operator's manual
-  Always wear eye protection and use proper personal protective equipment.
-  Wear non-slip safety footwear
-  Wear protective gloves
-  Keep tool at least 15m (50') away from electric power lines.
-  Keep bystanders at least 15m (50') away during use.
-  Avoid contact with bar tip
-  **⚠ DANGER** Beware of kickback.
-  Chain Oil Reservoir
-  Chain Direction
-  Chain Tension Adjustment
-  Regulatory Compliance Mark (RCM). This product meets applicable regulatory requirements.

SPECIFICATIONS

Cat. No.	M18 FOPH-CSA
Power Head	M18 FOPH
91cm (3') Extension Attachment	M18 FOPH-EXA
RPM	High 0 - 4600 Low 0-3700
Chain Speed	8.6 m/s
Bar Length	10" (254 mm)
Cutting Capacity	9" (230 mm)
Min Branch Diameter	6 mm (1/4")
Max Branch Diameter	230 mm (9")
Chain Oil Tank Capacity	140ml
Bar Groove Width	0.043" (1.1 mm)
Replacement Chain	49162723
Chain Type	Low Kickback
Chain Pitch	3/8" (9.5 mm) Low Profile
Chain Drive Teeth	40

ASSEMBLY

WARNING Before use, read manual and labels of the power head. Important assembly and use instructions are provided in the power head manual. Connect the attachment to the power head in accordance with the power head manual.

Always remove battery pack before changing or removing accessories.

CAUTION Chain is sharp. Always wear protective gloves when handling the chain.

Replacing/Adjusting the Saw Chain and Bar

Use Low Kickback Saw Chains - The rakers (depth gauges) ahead of each cutter can minimise the force of a kickback reaction by preventing the cutters from digging in too deeply at the kickback zone. Only use replacement chain that is equivalent to original chain or has been certified as low kickback chain per ANSI B175.1.

As saw chains are sharpened during their useful life, they lose some of the low kickback qualities and extra caution should be used.

1. Remove the battery pack.
2. Place the tool on a flat, firm surface.
3. Remove the drive cover by removing the guide bar nuts using the adjustment tool.

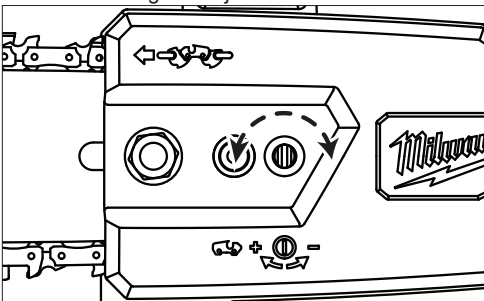

4. Loosen the chain by turning the chain tensioning screw counterclockwise with the adjustment tool.
5. Pull the guide bar off of the guide bar bolts and unloop the chain from the drive hub. **CAUTION!** Saw Chain is sharp.
6. Remove the chain from the guide bar groove. **CAUTION!** Saw Chain is sharp. Inspect guide bar for cracks or wear; replace if damaged.

7. Wrap the new or sharpened chain around the guide bar in the direction indicated on the tool

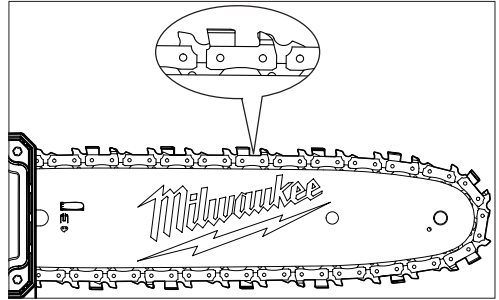

8. Ensure the chain is properly set in the slot around the entire guide bar.

9. Loop the chain around the hub and fit the bar around the bolt.

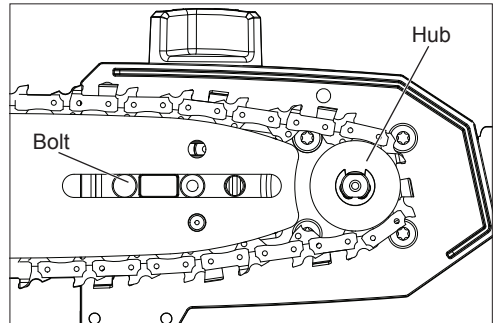

10. Replace the drive cover.
11. Use the adjustment tool to rotate the chain tensioning screw to increase tension (clockwise) until the chain is snug around the guide bar.
 - The tension is correct when the chain snaps back after being pulled 3mm (1/8") away from the guide bar. No sag should be visible in the chain.

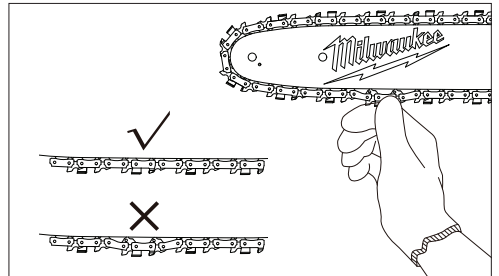

- Do not over-tension the chain - excess tension will cause excessive wear and will reduce the life of the chain and could damage the bar.
 - New chains could stretch and loosen during initial use. Remove battery pack and check chain tension frequently during the first two hours of use.
12. Tighten the guide bar nuts securely.

Attaching the Shoulder Strap

When using this attachment with larger-capacity battery packs, use the shoulder strap to reduce user fatigue and help in maintaining control of the tool during use.

To **install** the strap:

1. Remove the battery pack.
2. Fit the pole clip around the power head pole between the front handle and rear handle in a location comfortable during use.
3. Insert the bolt through the pole clip and strap bevel. Thread the nut onto the bolt and tighten securely.
4. Clip the strap carabiner to the bevel.

To **wear** the strap:

1. Put your right arm and head through the strap.
2. Adjust the strap clips to change the strap length to fit comfortably.
3. Slide the neck pad to the appropriate position.

To **unclip** the strap:

1. Hold the tool by the front handle with your left hand.
2. Grip the carabiner with your right hand and unclip by pushing in the gate and it sliding off the bevel.

Quik-Lok™ System Extension Attachment

(M18 FOPH-EXA)

Do not extend tool by more than one extension attachment. Additional extension attachments will make the pole unstable and difficult to control, which could result in injury.

To **install** an attachment or extension:

1. Remove battery pack.
2. Loosen the lock knob.
3. Slide the pole into the latch. The detent on the pole should line up with the slot in the latch.
4. Push the sections together securely. Tug on the poles to ensure they are secure.
5. Tighten the lock knob.

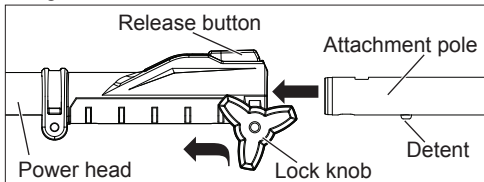

To **remove** an attachment or extension:

1. Remove battery pack.
2. Loosen the lock knob.
3. Push in the release button and pull the poles apart.

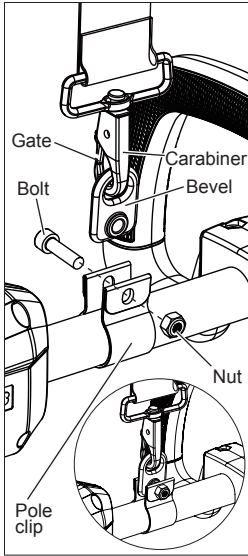

Chain Oil

WARNING Always remove battery pack before changing or removing accessories.

NOTICE Fill oil reservoir with chain oil (not provided) before starting the tool and when tank is less than 1/4 full. Failure to oil the chain will cause damage to the bar and chain.

Check oil level frequently and fill the oil reservoir after each full battery discharge. Use a high quality chain oil. The oil will keep the saw chain and guide bar properly lubricated. Never run the tool without chain oil. Keep the reservoir more than 1/4 full to ensure sufficient oil is available for the job. Always lightly oil the chain when storing to prevent rust. Always empty the oil tank when storing to prevent leakage.

NOTE: It is recommended to use a vegetable based chain oil when pruning trees. Mineral oil may harm trees. Never use waste oil automotive oil, or very thick oils. These could damage the tool.

Filling the Oil Reservoir

1. Remove the battery pack.
2. Place the tool on a flat, firm surface, blade side down.
3. Unscrew the oil cap.
4. Carefully fill reservoir with chain oil.
5. Tighten oil cap securely.
6. Repeat as needed during use.
7. Periodically check that the saw chain is lubricating correctly:

- With a full reservoir, hold the tool with the tip of the guide bar pointing down toward a light-colored surface.
- Run the tool for approximately 30 seconds.
- An oil line should become visible on the light surface.
- If not, remove and clean the guide bar thoroughly. Ensure the guide bar sprocket (at the tip) rotates freely.
- If the lubrication system still does not work properly, contact a *MILWAUKEE*® service facility.

Transporting Tool

WARNING Carry the tool by the front handle to avoid accidental starting. Proper handling of the tool will prevent injury.

Always turn off the tool when transporting from one location to another. Do not carry tool with finger on the trigger. Accidental starting can cause serious personal injury.

Before transporting, always:

1. Remove the battery pack
2. Place the cover over the guide bar.

Selecting the Speed

When using this attachment, only HIGH SPEED is recommended. Use the speed control button to select HIGH SPEED.



OPERATION

⚠ DANGER

Never cut near power lines, electric cords, or other electric sources. If bar and chain jams on any electrical cord or line, DO NOT TOUCH THE BAR OR CHAIN! THEY CAN BECOME ELECTRICALLY LIVE AND VERY DANGEROUS. Continue to hold the tool by the insulated rear handle or lay it down and away from you in a safe manner. Disconnect the electrical service to the damaged line or cord before attempting to free the bar and chain from the line or cord. Contact with the bar, chain, other conductive parts of the tool or live electric cords or lines will result in death by electrocution, electric shock, or serious personal injury.



⚠ WARNING

Read and understand all instructions. Failure to follow all instructions listed below may result in electric shock, fire and/or serious personal injury.

- Guard Against Kickback which can result in severe injury or death. See Important Safety Instructions "Guard Against Kickback", to avoid the risk of kickback.
- Always wear eye protection with side shield, as well as head and hearing protection. Failure to do so could result in objects being thrown into your eyes and other possible serious injuries.
- Do not overreach. Do not cut with right hand holding tool above chest height. Make sure

your footing is firm. Keep feet apart. Divide your weight evenly on both feet.

- Do not allow familiarity with this product to make you careless. Remember that a careless fraction of a second is sufficient to inflict serious injury.
- Use a firm grip with your left hand on the front handle and your right hand on the rear handle so that your body is to the left of the guide bar.
- Never use a cross-handed grip (left hand on the rear handles and right hand on the front handle).
- Never allow any part of your body to be in line with the guide bar when operating the tool.
- Never operate while in a tree, in any awkward position or on a ladder or other unstable surface. You may lose control of tool causing severe injury.
- Never fell a tree or cut a log or limb that has a diameter greater than the length of the guide bar. Only properly trained professionals should perform these cuts. Performing these types of cuts can cause an accident and result in death or serious personal injury.
- Keep the tool running at full speed the entire time you are cutting.
- Allow the chain to cut for you. Exert only light pressure. Do not put pressure on tool at end of cut.
- When not in use always remove the battery.
- Do not use any attachments or accessories not recommended by the manufacturer. The use of attachments or accessories not recommended can result in serious personal injury.

Kickback

⚠ WARNING

Kickback may occur when the moving chain contacts an object at the upper portion of the tip of the guide bar or when the wood closes in and pinches the saw chain in the cut. Contact at the upper portion of the tip of the guide bar can cause the chain to dig into the object and stop the chain for an instant. The result is a lightning fast, reverse reaction which kicks the guide bar up and back toward the operator. If the saw chain is pinched along the top of the guide bar, the guide bar can be driven rapidly back toward the operator. Either of these reactions can cause loss of tool control which can result in serious injury. Do not rely exclusively upon the safety devices built into the tool. As a pole saw user, you should take several steps to keep your cutting jobs free from accident or injury.

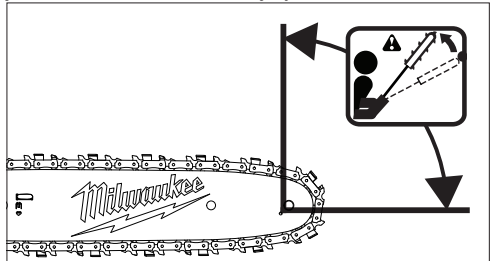
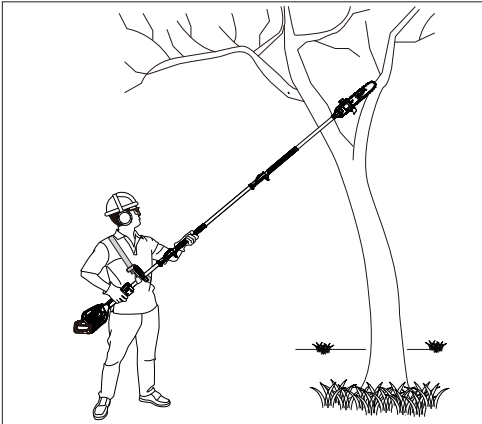

The following precautions should be followed to minimize kickback:

- Always grip the tool firmly with both hands. Hold the tool firmly with both hands when the unit is running.
- The tool can be held in multiple orientations depending on the grip used. Keep your right hand on the trigger handle and grip either the front handle or pole hand grip with your left hand. To increase control, always hold the tool using the hand grip when using the attachment extension.
- Use your thumbs and fingers to fully encircle the tool handles. A firm grip together with a stiff left arm will help you maintain control of the tool if kickback occurs.

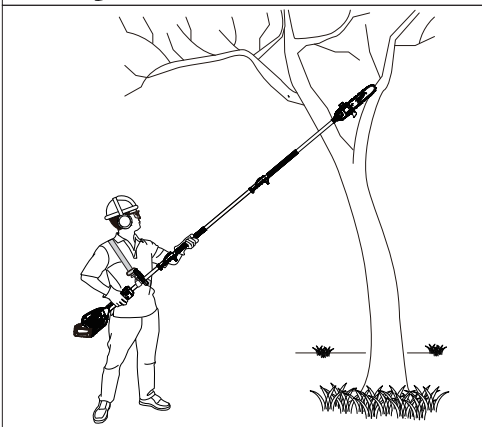
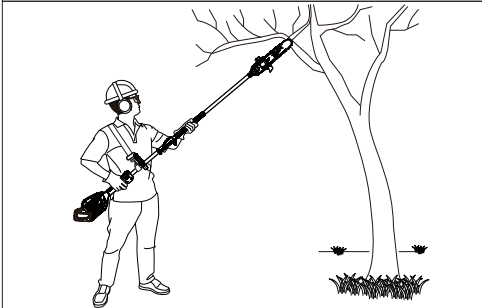
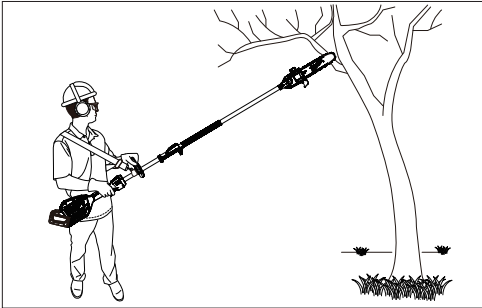

- Make sure that the area in which you are cutting is free from obstructions. Do not let the nose of the guide bar contact a log, branch, fence, or any other obstruction that could be hit while you are operating the tool.
- Always cut with the unit running at full speed. Fully squeeze the throttle trigger and maintain a steady cutting speed.
- Use replacement parts such as low kickback chain and special guide bars that reduce the risks associated with rotational kickback. Use only the replacement guide bars and low kickback chains specified by the manufacturer for the tool.

With a basic understanding of kickback, you can reduce or eliminate the element of surprise. Sudden surprise contributes to accidents.

- Keep proper footing and balance at all times.
- Do not cut with right hand holding power unit above shoulder height. Do not overreach when cutting.
 - Follow the sharpening and maintenance instructions for the saw chain.
 - Push and Pull - This reaction force is always opposite to the direction the chain is moving where wood contact is made. Thus, the operator must be ready to control the PULL when cutting on the bottom edge of the bar, and PUSH when cutting along the top edge.

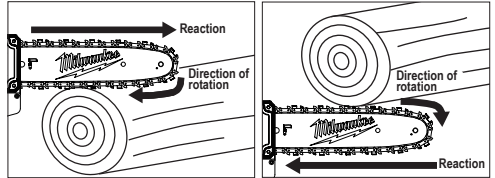

Turning the Tool On / Off

WARNING Always be sure of your footing and grip the tool firmly with both hands. The fingers should encircle the handle and the thumb should be wrapped under the handlebar to resist kickback. Keep body to the left of the chain line. Always keep your left hand on the front handle and your right hand on the rear handle so that your body is to the left of the chain line. Never straddle the saw or chain, or lean over past the chain line.

Wear non-slip gloves for maximum grip and protection.

1. **WARNING!** Always remove the guide bar cover before use.
2. Insert the battery pack.
3. Grip the tool securely with both hands, keeping body out of line with the chain.
4. To **start** the tool, squeeze the lock-off lever and pull the trigger.
5. Allow tool to come to full speed before contacting workpiece.
6. To **vary** the speed, increase or decrease the pressure on the trigger. The further the trigger is pulled, the greater the speed up to the maximum set by the speed control button.
7. To **stop** the tool release the trigger. Make sure the tool comes to a complete stop before laying the tool down.

WARNING Never attempt to lock the trigger in the ON position.

Proper Cutting Stance

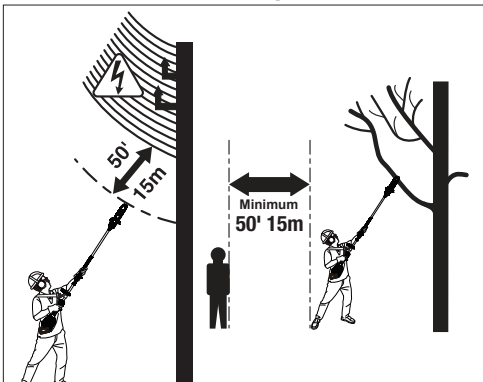

WARNING Always use the proper cutting stance described in this section. Never kneel when using the tool. Kneeling could result in loss of stability and control of the tool resulting in serious personal injury.

- Weight should be balanced with both feet on solid ground.
- Your body should always be to the left of the chain line.
- Thumb should be on underside of handlebar.

Basic Cutting Procedure

Practice cutting a few small logs using the following technique to get the "feel" of using the tool before you begin a major sawing operation.

- Take the proper stance in front of the wood with the tool off.
- Squeeze the switch trigger and let the chain accelerate to full speed before entering the cut.
- Begin cutting with the saw against the log.
- Keep the unit running the entire time you are cutting, maintain a steady speed.
- Allow the chain to cut for you; exert only light downward pressure. If you force the cut, damage to the bar, chain, or unit can result.
- Release the switch trigger as soon as the cut is completed, allowing the chain to stop. If you run the tool without a cutting load, unnecessary wear can occur to the chain, bar, and unit.
- Do not put pressure on the tool at the end of cut.

Work Area Precautions

- Cut only wood or materials made from wood, no sheet metal, no plastics, no masonry, no non-wood building materials.
- Never allow children to operate the tool. Allow no person to use this tool who has not read this Operator's Manual or received adequate instructions for the safe and proper use of this tool.
- When cutting, keep everyone - helpers, bystanders, children, and animals - a safe distance from the cutting area. Trees should not be trimmed in a manner that would endanger any person, strike any utility line or cause any property damage. If a branch does make contact with any utility line, the utility company should be notified immediately.
- Always cut with both feet on solid ground to prevent being pulled off balance.

- During use, right hand holding power unit should not rise above chest height. Holding power head higher is difficult to control against kickback forces.
- Do not trim trees near electrical wires or buildings. Leave this operation for professionals.
- Cut only when visibility and light are adequate for you to see clearly.
- Check work area for hazards such as bees, rodents, snakes, etc., that may live in trees or brush.

WARNING Never climb into a tree to limb or prune. Do not stand on ladders, platforms, a log, or in any position which can cause you to lose your balance or control of the tool.

Pruning

WARNING If the limbs to be pruned are out of the reach of the pole saw, hire a professional to perform the pruning. Failure to do so could result in serious personal injury.

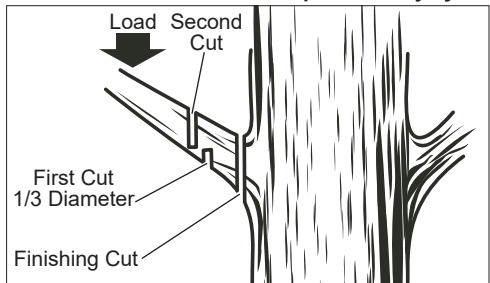

Pruning is trimming limbs from a live tree.

- Work slowly, keeping both hands on the tool with a firm grip. Always make sure your footing is secure and your weight is distributed evenly on both feet.
- Do not cut from a ladder, this is extremely dangerous. Leave this operation for professionals.
- During use, right hand holding power unit should not rise above chest height. Holding power head higher is difficult to control against kickback forces.
- When pruning trees it is important not to make the finishing cut next to the main limb or trunk until you have cut off the limb further out to reduce the weight. This prevents stripping the bark from the main member.
- Underbuck the branch 1/3 through for your first cut.
- Your second cut should overbuck to drop the branch off.
- Now make your finishing cut smoothly and neatly against the main member so the bark will grow back to seal the wound.

Pull Hook

Use the pull hook to grab the trimmed branches and pull them from the tree canopy.

Limbing

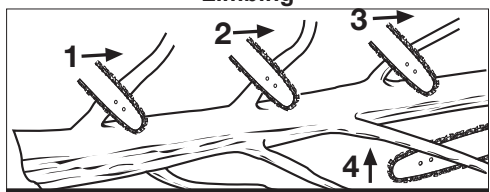

Cut limbs one at a time and leave support limbs under tree until log is cut

MAINTENANCE

⚠WARNING To reduce the risk of injury, always unplug the charger and remove the battery pack from the charger or tool before performing any maintenance. Never disassemble the tool, battery pack or charger. Contact a MILWAUKEE® service facility for ALL repairs.

Maintaining Tool

Keep your tool, battery pack and charger in good repair by adopting a regular maintenance program. Inspect your tool for issues such as undue noise, misalignment or binding of moving parts, breakage of parts, or any other condition that may affect the tool operation. Return the tool, battery pack, and charger to a MILWAUKEE® service facility for repair. After six months to one year, depending on use, return the tool, battery pack and charger to a MILWAUKEE® service facility for inspection.

If the tool does not start or operate at full power with a fully charged battery pack, clean the contacts on the battery pack. If the tool still does not work properly, return the tool, charger and battery pack, to a MILWAUKEE® service facility for repairs.

Chain and Bar

After every few hours of use, remove the drive cover, guide bar and chain and clean thoroughly using a soft bristle brush. Ensure oiling hole on bar is clear of debris. When replacing dull chains with sharp chains it is good practice to flip the chain bar from bottom to top.

Sharpening the Saw Chain

⚠WARNING Improper chain sharpening increases the potential of kickback. Failure to replace or repair damaged chain can cause serious injury.

The saw chain is very sharp, always wear protective gloves when performing maintenance to the chain.

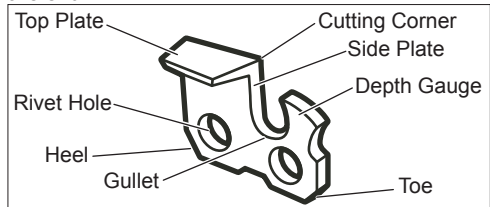

Be careful to file all cutters to the specified angles and to the same length, as fast cutting can be obtained only when all cutters are uniform.

•Wear gloves for protection. Properly tension the chain prior to sharpening. Refer to Chain Tension section earlier in this manual. Do all of your filing at the mid-point of the bar.

Limbing is removing branches from a fallen tree.

- Work slowly, keeping both hands on the tool with a firm grip. Always make sure your footing is secure and your weight is distributed evenly on both feet.
- Leave the larger support limbs under the tree to keep the tree off the ground while cutting.
- Limbs should be cut one at a time. Remove the cut limbs from the work area often to help keep the work area clean and safe.
- Branches under tension should be cut from the bottom up to avoid binding the tool.
- Keep the tree between you and the saw while limbing. Cut from the side of the tree opposite the branch you are cutting.

Springpoles

⚠WARNING Springpoles are dangerous and could strike the operator, causing the operator to lose control of the pole saw. This could result in severe or fatal injury to the operator.



A springpole is any log, branch, rooted stump, or sapling which is bent under tension by other wood so that it springs back if the wood holding it is cut or removed. On a fallen tree, a rooted stump has a high potential of springing back to the upright position during the bucking cut to separate the log from the stump. Watch out for springpoles, they are dangerous.

TROUBLESHOOTING

Problem	Cause	Solution
Bar and chain running hot and smoking.	Check chain tension for over tight condition.	Correct chain tension.
	Chain oil reservoir is empty.	Fill oil reservoir.
Motor runs, but chain is not rotating.	Chain tension too tight.	Correct chain tension.
	Guide bar and chain improperly assembled.	Correct assembly.
	Guide bar or chain is damaged.	Replace damaged parts before use.

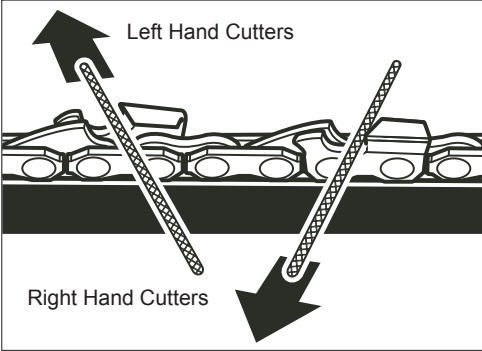
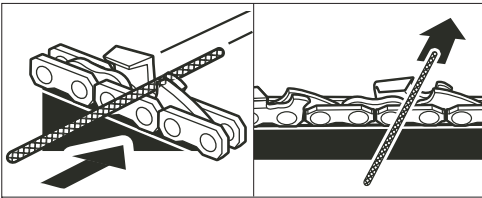

- Use a 3.96 mm (5/32") diameter round file and holder.
- Keep the file level with the top plate of the tooth. Do not let the file dip or rock.
- Using light but firm pressure, stroke towards the front corner of the tooth.
- Lift file away from the steel on each return stroke.
- Put a few firm strokes on every tooth. File all left hand cutters in one direction. Then move to the other side and file the right hand cutters in the opposite direction. Occasionally remove filings from the file with a wire brush.

Top Plate Filing Angle

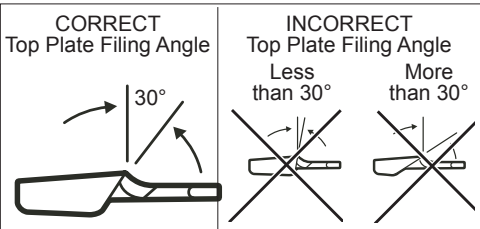

- **CORRECT 30°** - File holders are marked with guide marks to align file properly to produce correct top plate angle.
- **LESS THAN 30°** - For Cross Cutting.
- **MORE THAN 30°** - Feathered Edge Dulls Quickly.

Side Plate Angle

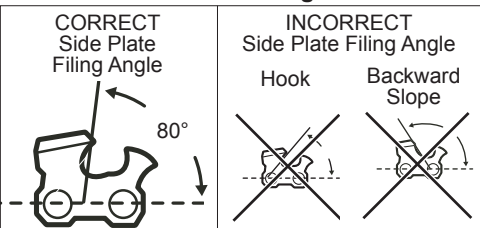

- **CORRECT** - 80° Produced automatically if correct diameter file is used in file holder.
- **HOOK** - "Grabs" and dulls quickly. Increases potential of KICKBACK. Results from using a file with diameter too small, or file held too low.
- **BACKWARD SLOPE** - Needs too much feed pressure, causes excessive wear to bar and chain. Results from using a file with diameter too large, or file held too high.

Depth Gauge Clearance

- The depth gauge should be maintained at a clearance of 0.6 mm. Use a depth gauge tool for checking the depth gauge clearances.
- Every time the chain is filed, check the depth gauge clearance.

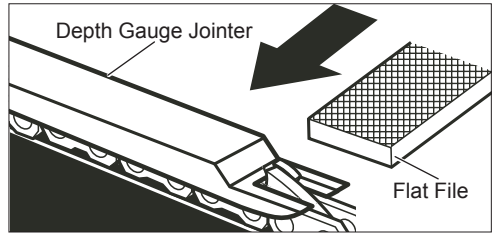

Use a flat file and a depth gauge jointer to lower all gauges uniformly. Depth gauge jointers are available in 0.5 mm to 0.89 mm Use a 0.63 mm depth gauge jointer.

After lowering each depth gauge, restore original shape by rounding the front. Be careful not to damage adjoining drive links with the edge of the file.

Depth gauges must be adjusted with the flat file in the same direction the adjoining cutter was filed with the round file. Use care not to contact cutter face with flat file when adjusting depth gauges.

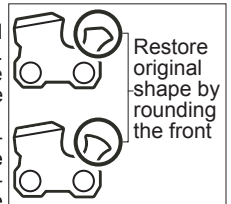

Restore original shape by rounding the front

Guide Bar Maintenance

When the guide bar shows signs of wear, reverse it on the tool to distribute the wear for maximum bar life. The bar should be cleaned every day of use and checked for wear and damage.

Feathering or burring of the bar rails is a normal process of bar wear. Such faults should be smoothed with a file as soon as they occur.

A bar with any of the following faults should be replaced.

- Wear inside the bar rails which permits the chain to lay over sideways.
- Bent guide bar.
- Cracked or broken rails.
- Spread rails.

Lubricate guide bars with a sprocket at their tip weekly. Using a grease syringe, lubricate weekly in the lubricating hole. Turn the guide bar and check that the lubrication holes and chain groove are free from impurities.

NOTE: Do not replace the screw with an ordinary screw. Use only identical replacement parts from the manufacturer when replacing parts.

⚠WARNING To reduce the risk of personal injury and damage, never immerse your tool, battery pack or charger in liquid or allow a liquid to flow inside them.

Cleaning

Clean dust and debris from vents. Keep handles clean, dry and free of oil or grease. Use only mild soap and a damp cloth to clean, since certain cleaning agents and solvents are harmful to plastics and other insulated parts. Some of these include gasoline, turpentine, lacquer thinner, paint thinner, chlorinated cleaning solvents, ammonia and household detergents containing ammonia. Never use flammable or combustible solvents around tools.

Repairs

For repairs, return the tool, battery pack and charger to the nearest service centre.

ACCESSORIES

⚠WARNING Use only recommended accessories. Others may be hazardous.

For a complete listing of accessories, go online to milwaukeeetools.com.au/ www.milwaukeeetools.co.nz or contact a distributor.

WARRANTY - AUSTRALIA and NEW ZEALAND

Please refer to Australian and New Zealand warranty supplied with tool. This warranty applies only to product sold in Australia and New Zealand.

SERVICE - AUSTRALIA and NEW ZEALAND

MILWAUKEE® prides itself in producing a premium quality product that is Nothing But Heavy Duty®. Your satisfaction with our products is very important to us! If you encounter any problems with the operation of this tool, please contact your authorised **MILWAUKEE®** dealer.

For a list of **MILWAUKEE®** dealers, guarantee or service agents please contact **MILWAUKEE®** Customer Service or visit our website.

(Australia Toll Free Telephone Number 1300 645 928)

(New Zealand Toll Free Telephone Number 0800 279 624)

or visit www.milwaukeetools.com.au / www.milwaukeetools.co.nz.

Milwaukee Electric Tool Corporation

13135 West Lisbon Road, Brookfield, Wisconsin U.S.A. 53005

Milwaukee Tool (Australia)

21 Kelleys Road, Rowville, VIC 3178
Melbourne, Australia

Milwaukee Tool (New Zealand)

2 Landing Drive, Mangere
Auckland, 2022, New Zealand

Designed by Milwaukee Electric Tool Corp.

Professionally Made in China for Milwaukee Tool (Australia) / Milwaukee Tool (New Zealand)

Printed in China